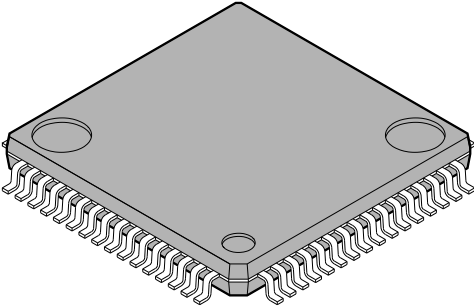

QUAD FLAT L-LEADED PACKAGE 64 PIN PLASTIC

FPT-64P-M09

EIAJ code : *QFP064-P-1212-1

<p>64-pin plastic QFP</p>  <p>(FPT-64P-M09)</p>	Lead pitch	0.65mm	
	Package width × package length	12 × 12mm	
	Lead shape	Gullwing	
	Sealing method	Plastic mold	

64-pin plastic QFP
(FPT-64P-M09)

